

# Levitt

Ludovica + Roberto Palomba

Is a collection of sofas, armchairs and complements totally modular that allow to multiply compositions and finishes.

Please, provide a sketch with the order to avoid misunderstandings, and taking into account that right left is always facing the element.

The seat deepness is 90 cm without cushions so if you need a shorter seat, you should order the cushions for the back.

The direction of the fabric in the chaise lounge and similar sizes options will be the opposite to the side unit to avoid visible sewing.

In case to upholster with 2 different fabrics, the higher category will be taken for the total price.

The tolerance of the different elements can be +/- 3 cm.

Indicate in the order the cushion/back that you would like.

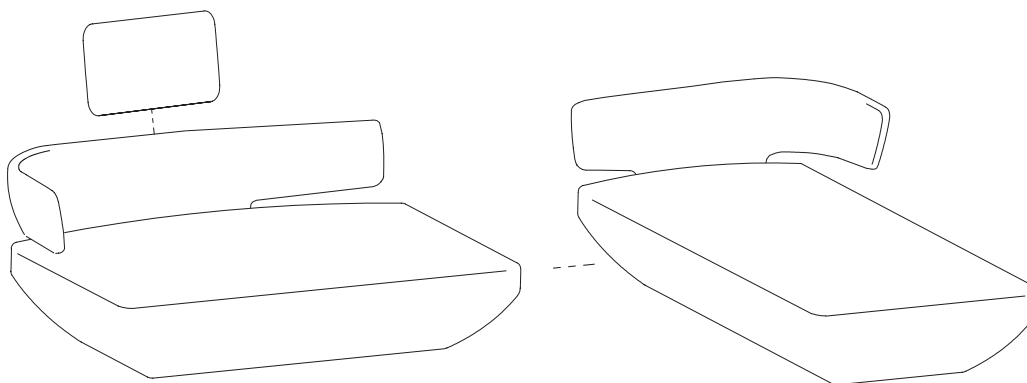

Backs in MDF curved wood and wood bases foamed in expanded indeformable polyurethane with different densities and polyester fiber.

Cushions in washed duck and goose feather with anti-acarus treatment. Anti-feather scape cotton cover.

Removable cover.

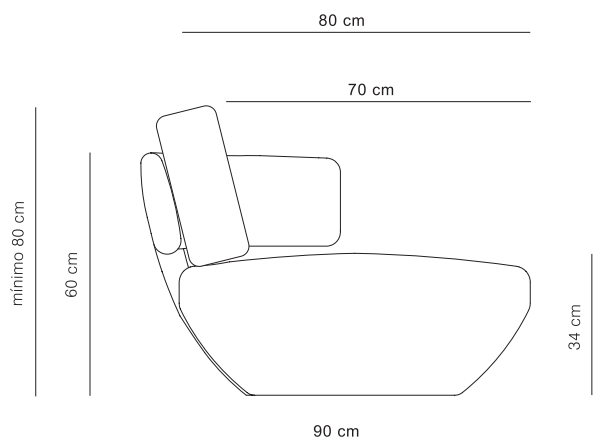

# Levitt

Ludovica + Roberto Palomba

## ARMCHAIR

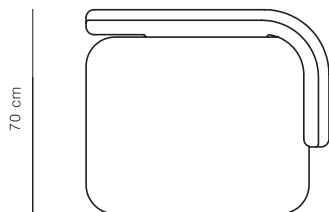
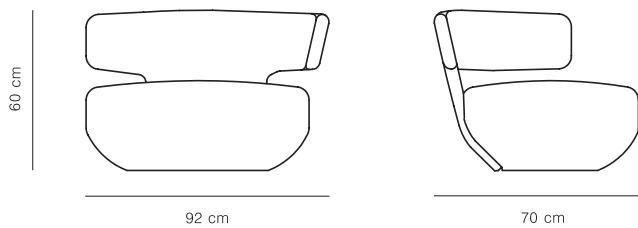

Needed fabric for material 1,40 wide:

ARMCHAIR= 3.45 m.

SOFA 152= 5.65 m.

SOFA 184= 6.90 m.

MODEL	VOLUME (m3)	WEIGHT (Kg)	FINISHES	
ARMCHAIR	0.54	22.3	COM	
			G2	
			G3	
			G4	
			G5	

## SOFA 152

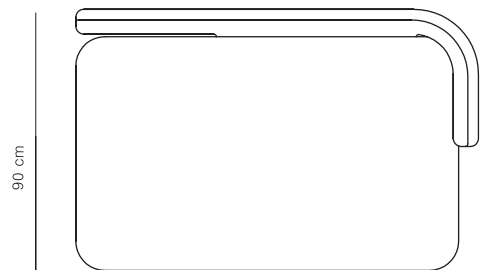
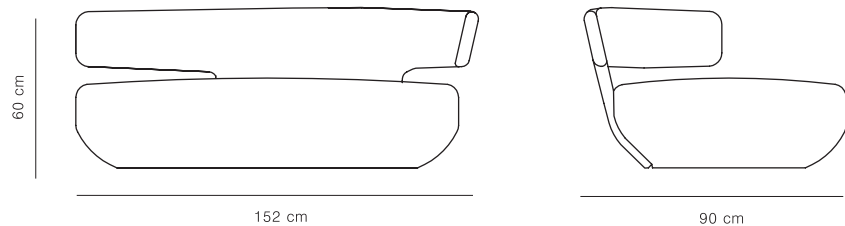

MODEL	VOLUME (m3)	WEIGHT (Kg)	FINISHES	
SOFA 152	0.82	49	COM	
			G2	
			G3	
			G4	
			G5	

## SOFA 184

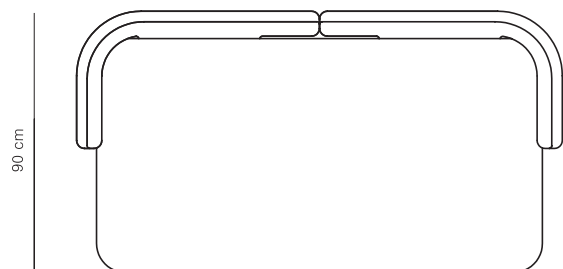
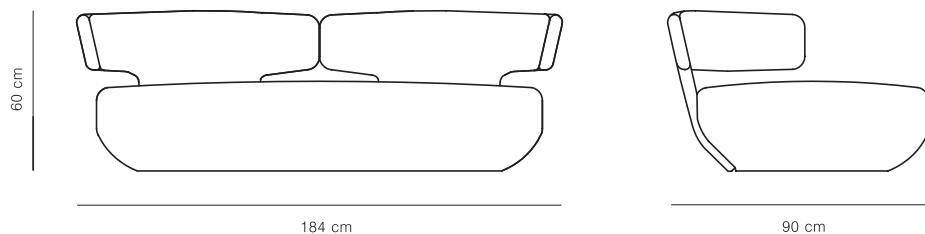

MODEL	VOLUME (m3)	WEIGHT (Kg)	FINISHES	
SOFA 184	1.33	55	COM	
			G2	
			G3	
			G4	
			G5	

# Levitt

Ludovica + Roberto Palomba

## SOFA 244

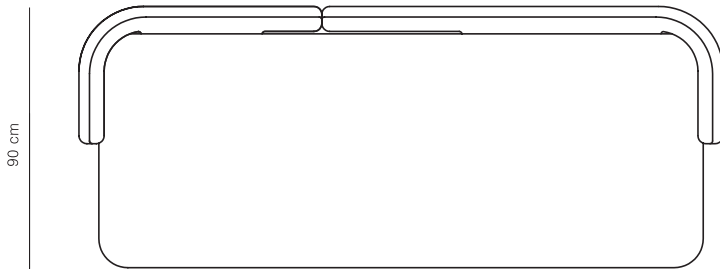
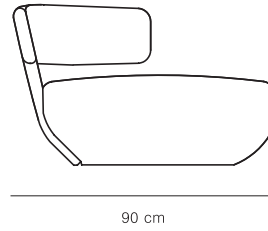
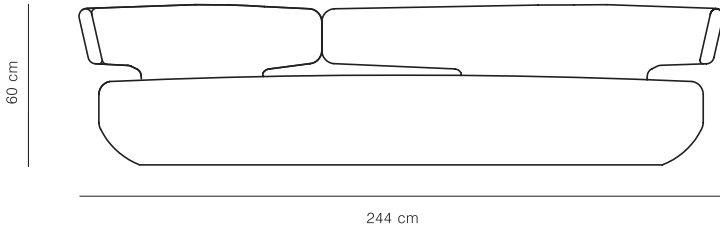

Needed fabric for material 1,40 wide:

SOFA 244= 8.85 m.

CHAISE= 4.70 m.

MODEL	VOLUME (m3)	WEIGHT (Kg)	FINISHES	
SOFA 244	1.75	72.25	COM	
			G2	
			G3	
			G4	
			G5	

## CHAISE

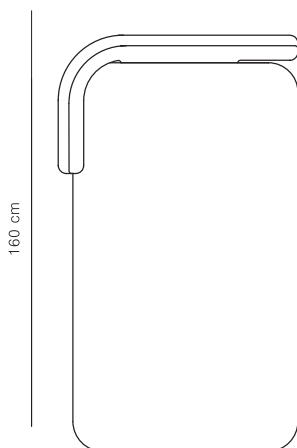
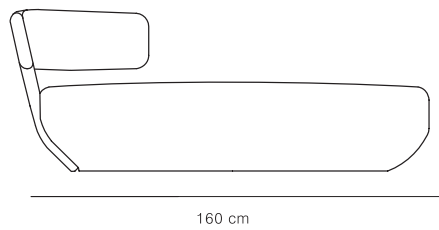
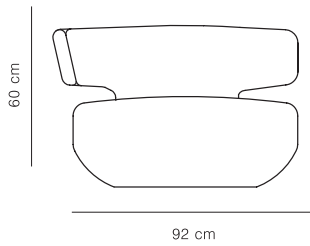

MODEL	VOLUME (m3)	WEIGHT (Kg)	FINISHES	
CHAISE	0.88	47	COM	
			G2	
			G3	
			G4	
			G5	

# Levitt

Ludovica + Roberto Palomba

## COMPOSITION L1

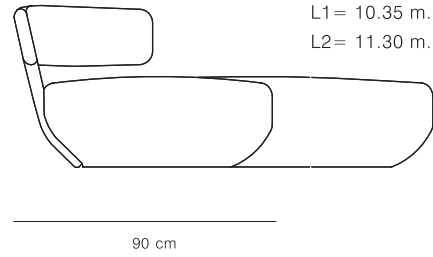
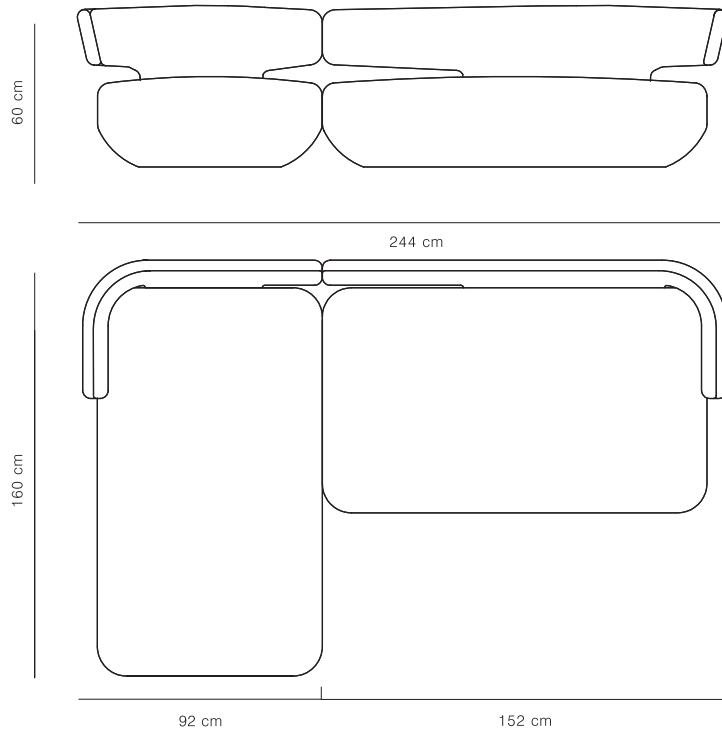

Needed fabric for material  
1,40 wide:  
L1 = 10.35 m.  
L2 = 11.30 m.

MODEL	VOLUME (m3)	WEIGHT (Kg)	FINISHES	
COMPOSITION L1	2.33	96.19	COM	
			G2	
			G3	
			G4	
			G5	

## COMPOSITION L2

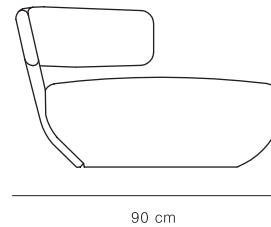
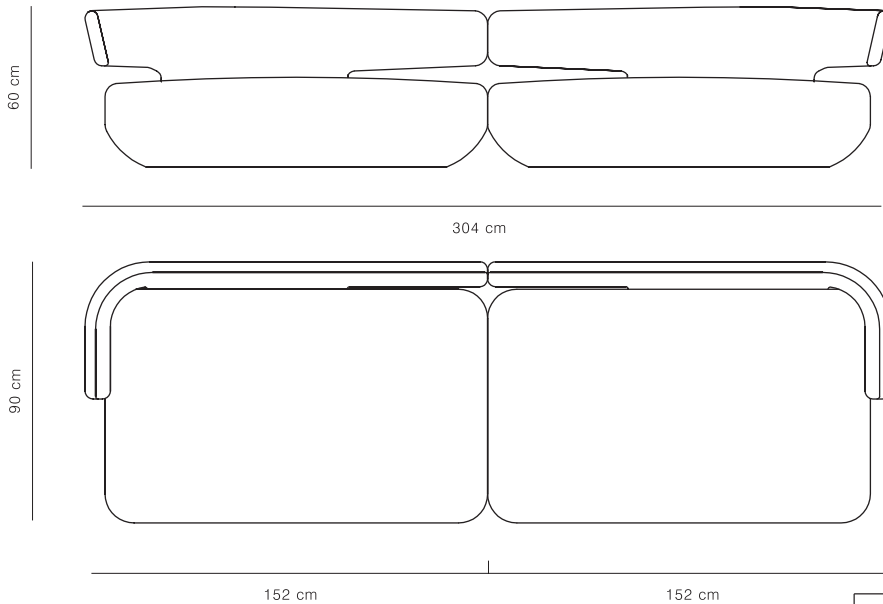

MODEL	VOLUME (m3)	WEIGHT (Kg)	FINISHES	
COMPOSITION L2	2.18	90	COM	
			G2	
			G3	
			G4	
			G5	

# Levitt

Ludovica + Roberto Palomba

LEAL70- BACK

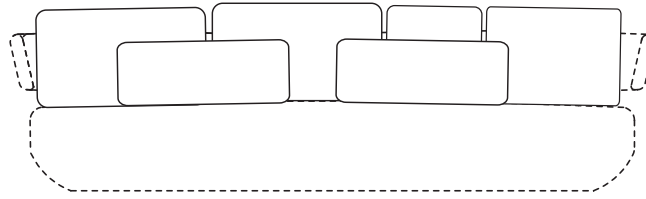
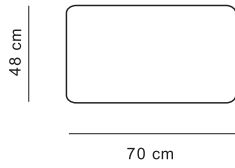

Needed fabric for material 1,40 wide:

LEAL70-1= 1m

LEAL55-1= 1m

LEAL35-1= 1m

LEAL48-1= 0,7m

LEAL55- BACK

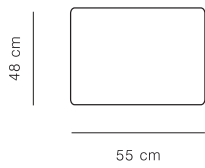

LEAL35- CUSHION

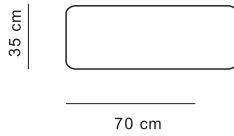

LEAL48- CUSHION

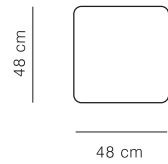

CODE	MODEL	VOL (m3)	WEIGHT (kg)	FINISHES	
LEAL70-1	BACK 70X48	0.1	2	COM	
LEAL70-2				G2	
LEAL70-3				G3	
LEAL70-4				G4	
LEAL70-5				G5	
LEAL55-1	BACK 55x48	0.1	2,2	COM	
LEAL55-2				G2	
LEAL55-3				G3	
LEAL55-4				G4	
LEAL55-5				G5	
LEAL35-1	CUSHION 70X35	0.1	1,7	COM	
LEAL35-2				G2	
LEAL35-3				G3	
LEAL35-4				G4	
LEAL35-5				G5	
LEAL48-1	CUSHION 48X48	0.1	1,7	COM	
LEAL48-2				G2	
LEAL48-3				G3	
LEAL48-4				G4	
LEAL48-5				G5	

# Levitt

Ludovica + Roberto Palomba



# Levitt

Ludovica + Roberto Palomba

